

SUPER MARIO 3 BROS.™

INSTRUCTION BOOKLET

Nintendo®

Nintendo of America Inc.
P.O. Box 957, Redmond, WA 98073-0957 U.S.A.

PRINTED IN JAPAN

This official seal is your assurance that Nintendo has reviewed this product and that it has met our standards for excellence in workmanship, reliability and entertainment value. Always look for this seal when buying games and accessories to ensure complete compatibility with your Nintendo Entertainment System.



Thanks for selecting the Super Mario Bros. 3™ Game Pak for your Nintendo Entertainment System.®

Please read this instruction booklet thoroughly to ensure proper handling of your new game. Then save this booklet for future reference.

CONTENTS

STORY	5
CONTROLLER OPERATION	6
NEW TECHNIQUES	11
MOVES YOU ALREADY KNOW	14
HOW TO PLAY SUPER MARIO BROS. 3	15
HOW TO PLAY THE 1 PLAYER GAME	16
HOW TO PLAY THE 2 PLAYER GAME	27
THE EIGHT KINGDOMS	30
THE CHARACTERS	35

PRECAUTIONS

- 1) This is a high precision Game Pak. It should not be stored in places that are very hot or cold. Never hit it or drop it. Do not take it apart.
- 2) Avoid touching the connectors. Do not get them wet or dirty. Doing so may damage the Game Pak and/or the Control Deck.
- 3) Do not clean with benzene, paint thinner, alcohol or other such solvents.
- 4) Store the Game Pak in its protective sleeve when not in use.
- 5) Always check the Game Pak edge connector for foreign material before inserting the Game Pak into the Control Deck.

Note: In the interest of product improvement, Nintendo Entertainment System specification and design are subject to change without notice.



A MESSAGE FROM MARIO

"Hello! How have you been? It's been such a long time since we've seen each other. Bowser is up to his old tricks again, so Luigi and I are going on another adventure. You're welcome to come along."

"This time it's Super Mario Bros. 3, the latest in the Super Mario Brothers series. You'll experience lots of excitement as your journey unfolds. For beginners and seasoned veterans of our previous games, this one is going to be a lot of fun! Let's look at Super Mario Bros. 3 in a bit more detail."

Bowser is back!!!

"Ha Ha Ha!
These are my 7 children that
are going to help me take over
the Mushroom World!"



These are Bowser's kids!!

LARRY KOOPA



MORTON KOOPA JR.



WENDY O. KOOPA



"We just love being mean!!"



ROY KOOPA



LEMMY KOOPA



LUDWIG VON KOOPA



IGGY KOOPA

STORY

The Mushroom Kingdom has been a peaceful place thanks to the brave deeds of Mario and Luigi. The Mushroom Kingdom forms an entrance to the Mushroom World where all is not well. Bowser has sent his 7 children to make mischief as they please in the normally peaceful Mushroom World. They stole the royal magic wands from each country in the Mushroom World and used them to turn their kings into animals. Mario and Luigi must recover the royal magic wands from Bowser's 7 kids to return the kings to their true forms. "Goodbye and good luck!" said the Princess and Toad as Mario and Luigi set off on their journey deep into the Mushroom World.



"We took 7 wands from the 7 kings. Each of us has one. Our father has instructed us to protect the wands."

CONTROLLER OPERATION

For the 1 player game use controller 1

For the 2 player game use controllers 1 and 2

Controller 1 / Controller 2

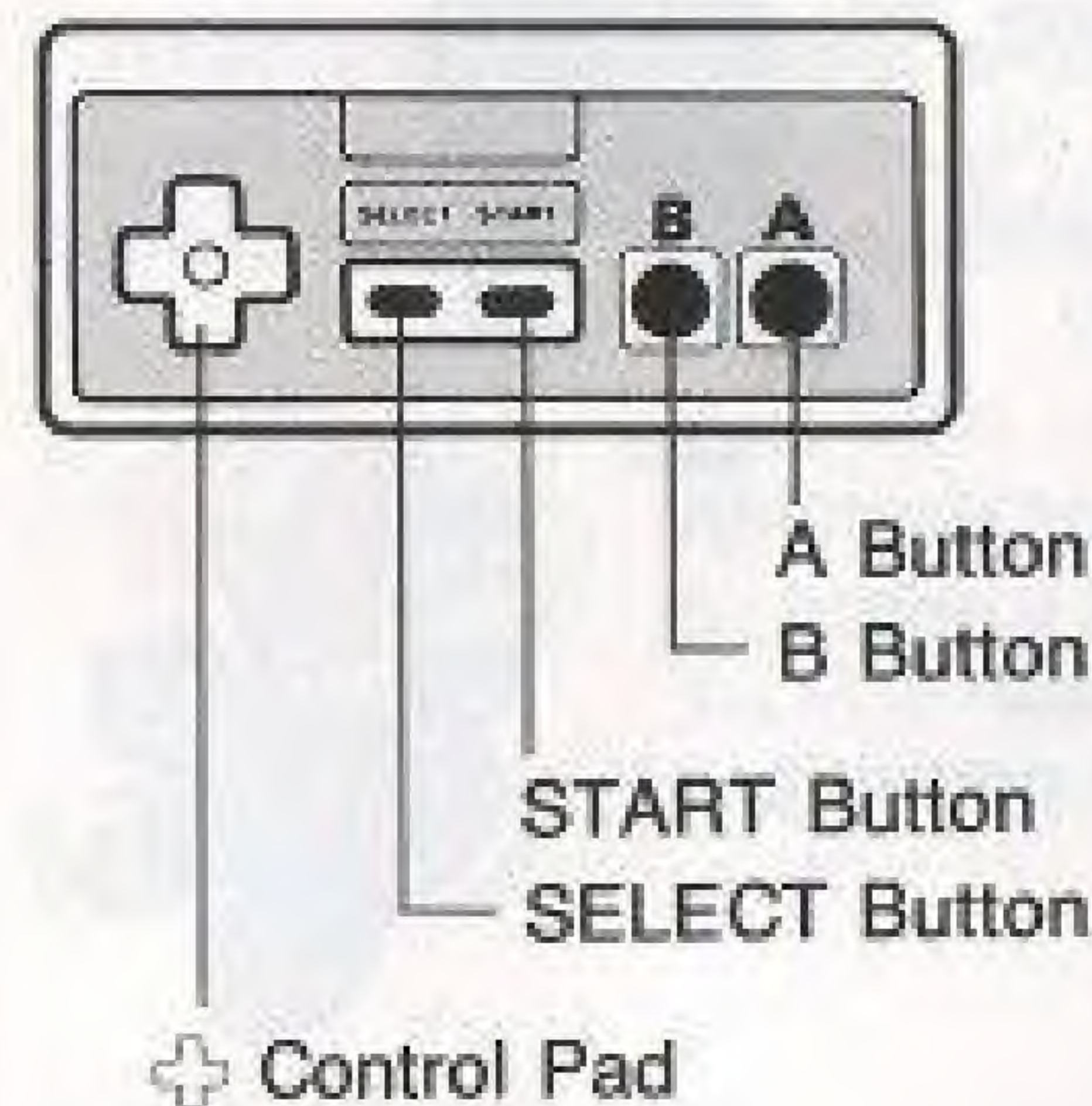

+ Control Pad

Up

- * Mario can enter a door.
- * If you press the A Button at the same time, Mario can jump up out of water.
- * If you press the A Button at the same time, Mario can enter some upside-down pipes.

Down

- * Mario can squat (except for Frog Mario.)
- * Mario can enter some pipes.
- * When the ground slopes, Mario can slide down it (except for Frog Mario.)

Left and Right

- * Mario can walk to the left and right. If you hold the B Button as you go left or right, Mario will run.

A Button

* Jump

The longer you press the A Button, the higher Mario will jump.

* Swim

In the water, Mario can swim by repeatedly pressing the A Button.

If Mario has the Frog Suit, he can swim by using just the  Control Pad. If you use the A Button, Mario can swim even faster.

* Fly/Float

After using the A Button to jump, Tanooki Mario and Raccoon Mario can fly or float for a limited time by pressing the A Button repeatedly.





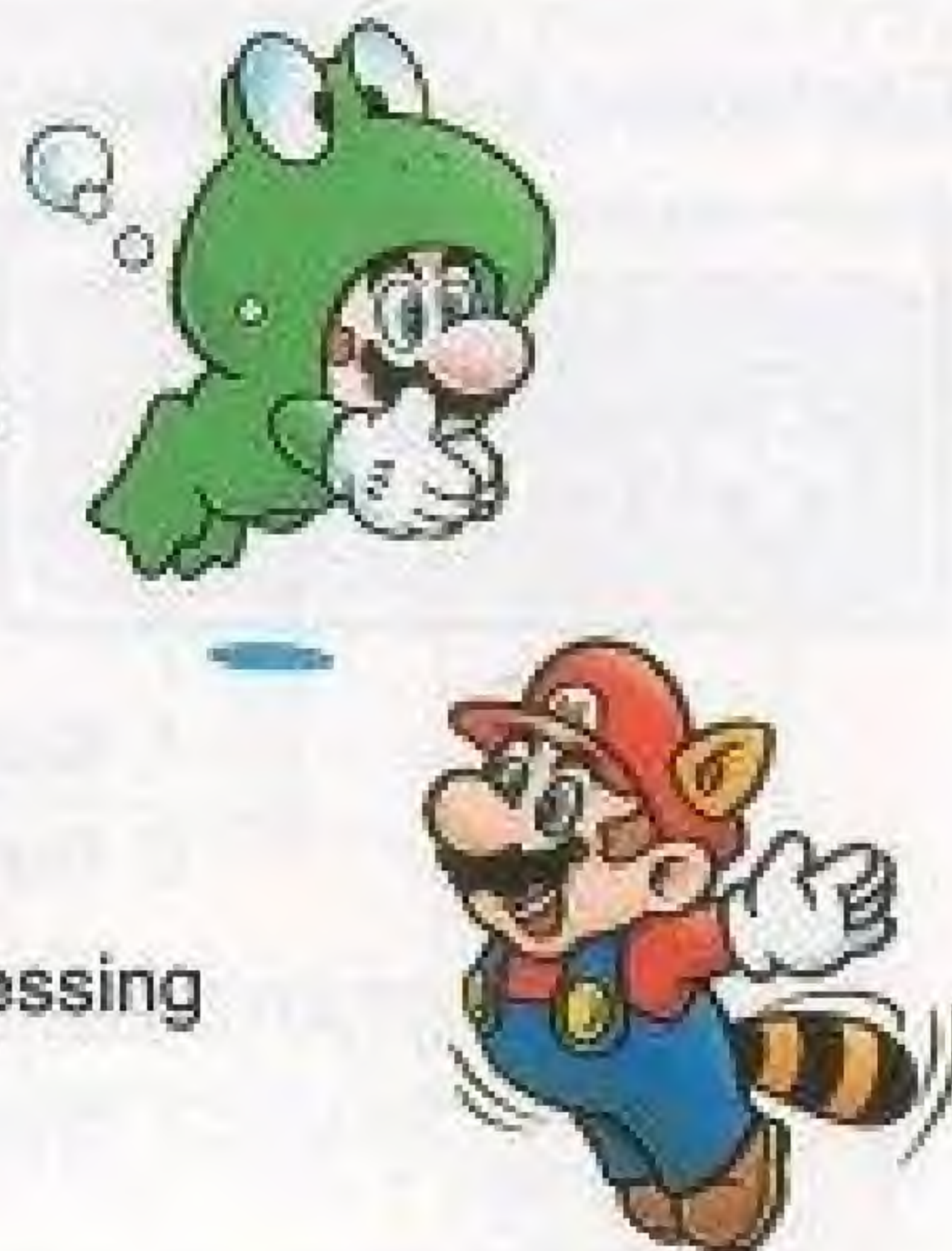

* Super Jump

When Mario jumps on an enemy, he can jump very high by pressing the A Button.



B Button

* Accelerate

Pressing the B Button while walking will make Mario accelerate. When Mario is moving fast, he can jump higher and farther. If you continue to accelerate, the Power Meter (       (P)) will increase. When the Power Meter is all the way to the top, Mario's arms open, a whistle blows and the (P) will flash. When this happens, you can press the A Button repeatedly to fly.



* Pick up a shell

After you have jumped on a Koopa, you can pick up the shell by hitting it from the side while you have the B Button pressed. To kick the shell, let go of the B Button. (Hint: This is very useful for breaking blocks in odd places.)

* Wag your tail

Tanooki Mario or Raccoon Mario can make a "tail attack" when you press the B Button. With your tail, you can break blocks and defeat some enemies.



- * **Throw Fireballs**

If Mario picks up a Fire Flower, he can throw fireballs by pressing the B Button.

- * **Turn into a Statue**

Tanooki Mario can turn into a statue for a short period of time by pressing the B Button and down on the  Control Pad at the same time. While Mario is a statue, he cannot be harmed.

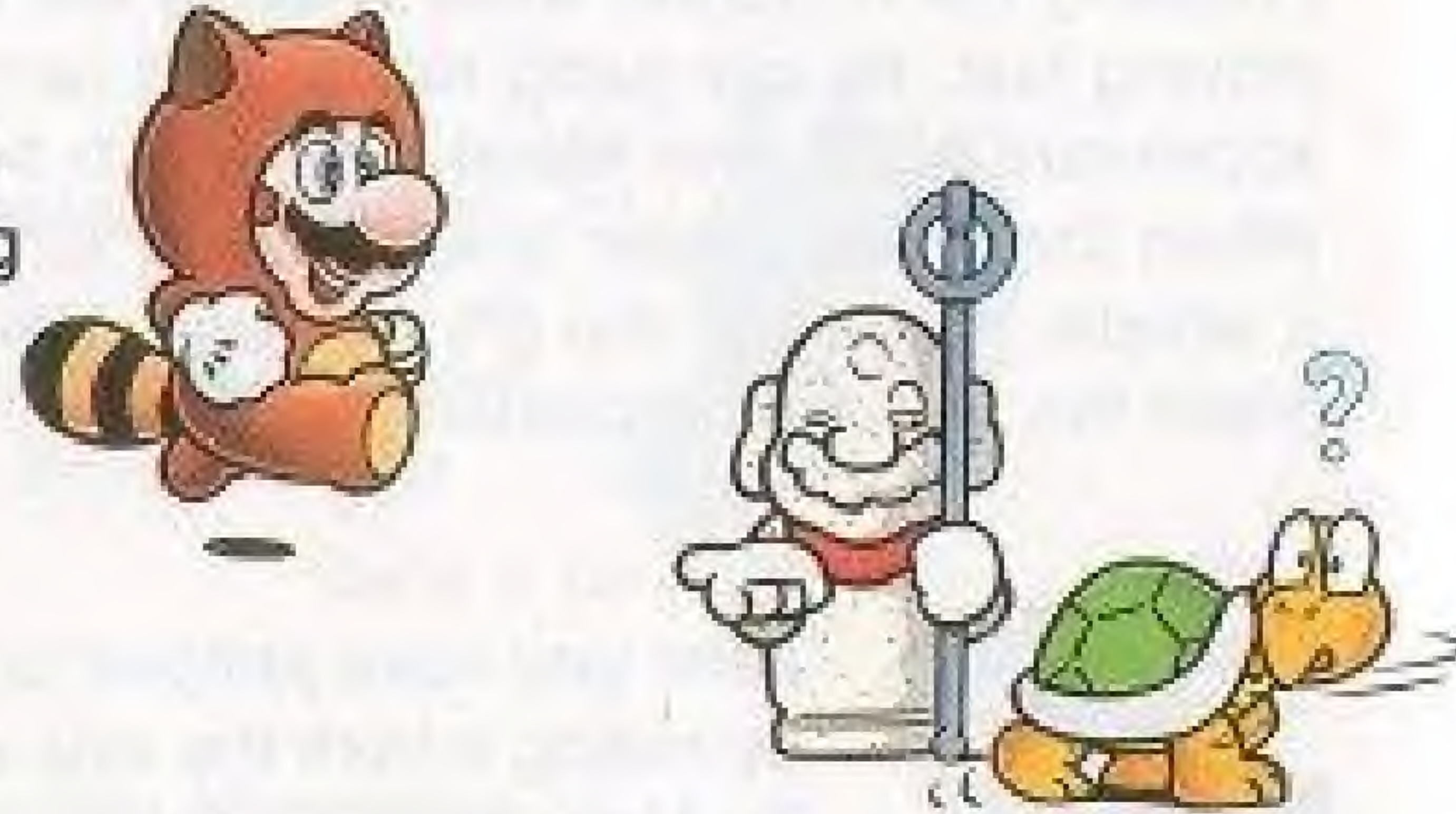

"Grrrr. You're pretty tricky. With all of these new moves, Mario will be difficult to beat. I'd better report this to our Dad!"

- * **SELECT Button**

The SELECT Button is used to move the cursor on the title screen and on the "game over" screen.



- * **START Button**

The START Button will start your game.

- * **Pause Function**

If you wish to pause your game, press the START Button. To resume play, press the START Button again.

NEW TECHNIQUES!



Holding a shell

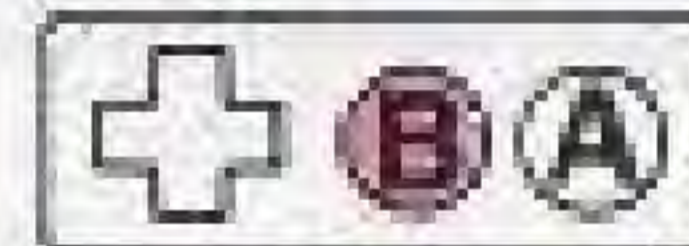

(Holding the B Button)



Running with a shell



(Holding the B Button)



Kicking the shell



(Releasing the B Button)



Breaking a block

When Mario has a tail



Accelerating



Power Meter going up



More acceleration



Meter full, (P) starting to flash



Take off

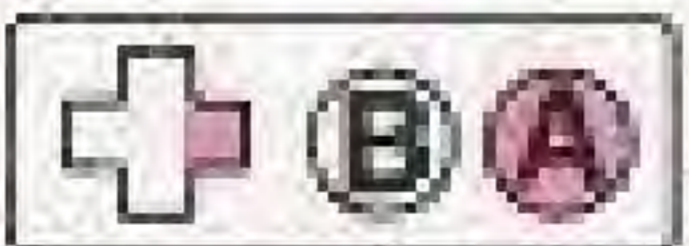

Press the A Button repeatedly



Mario can only fly for a short time.

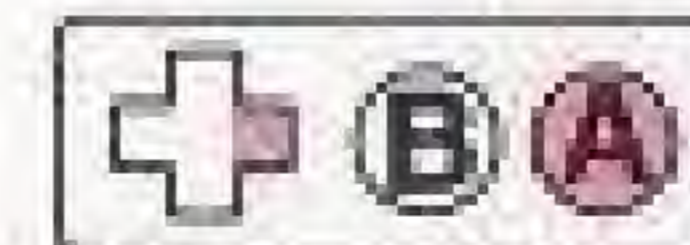

EVEN MORE NEW MOVES



Tail Attack

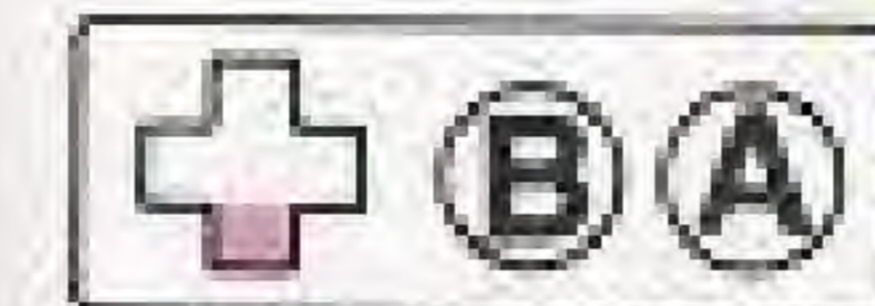
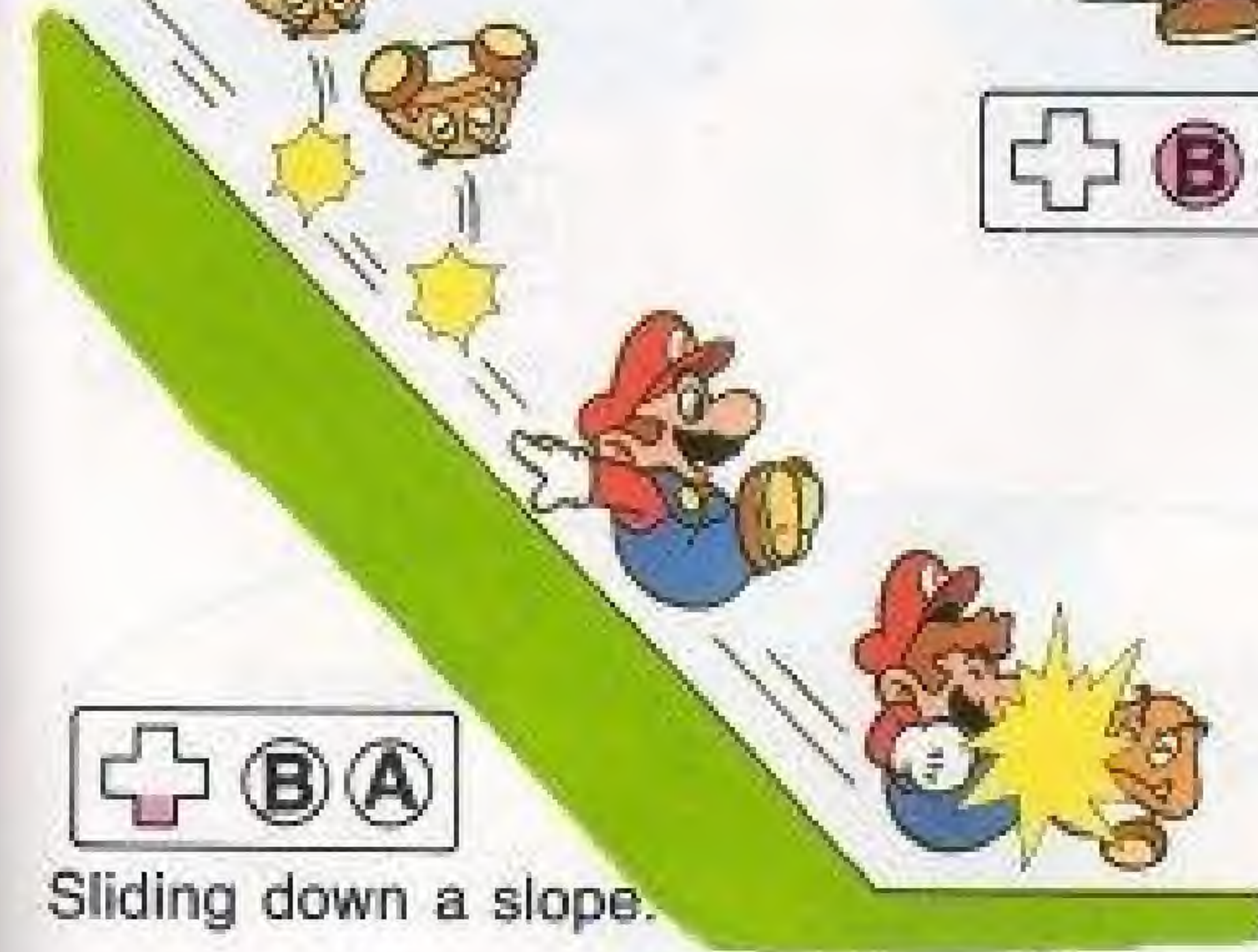

Sliding down a slope.

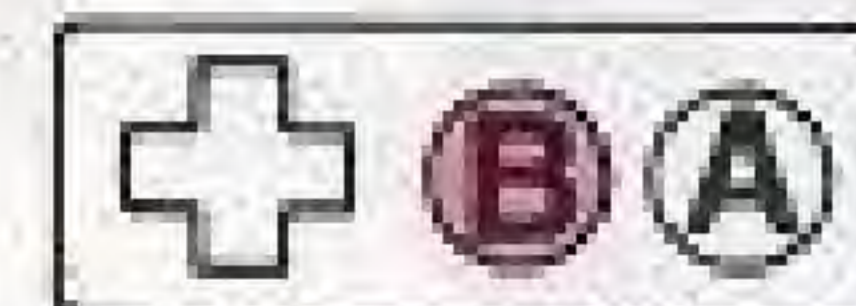

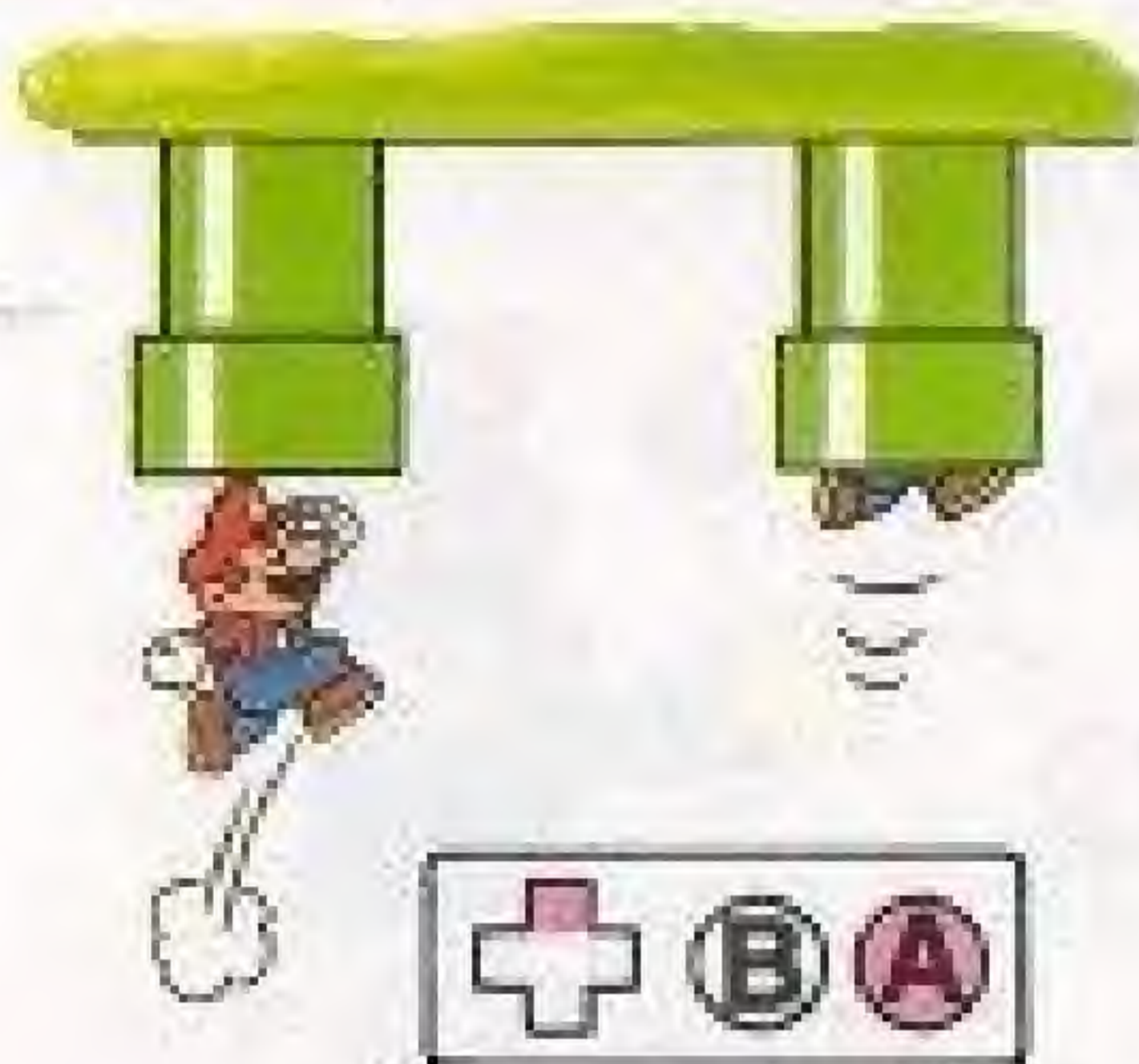

How to get into upside-down pipes

Use the A Button to make Frog Mario swim fast!

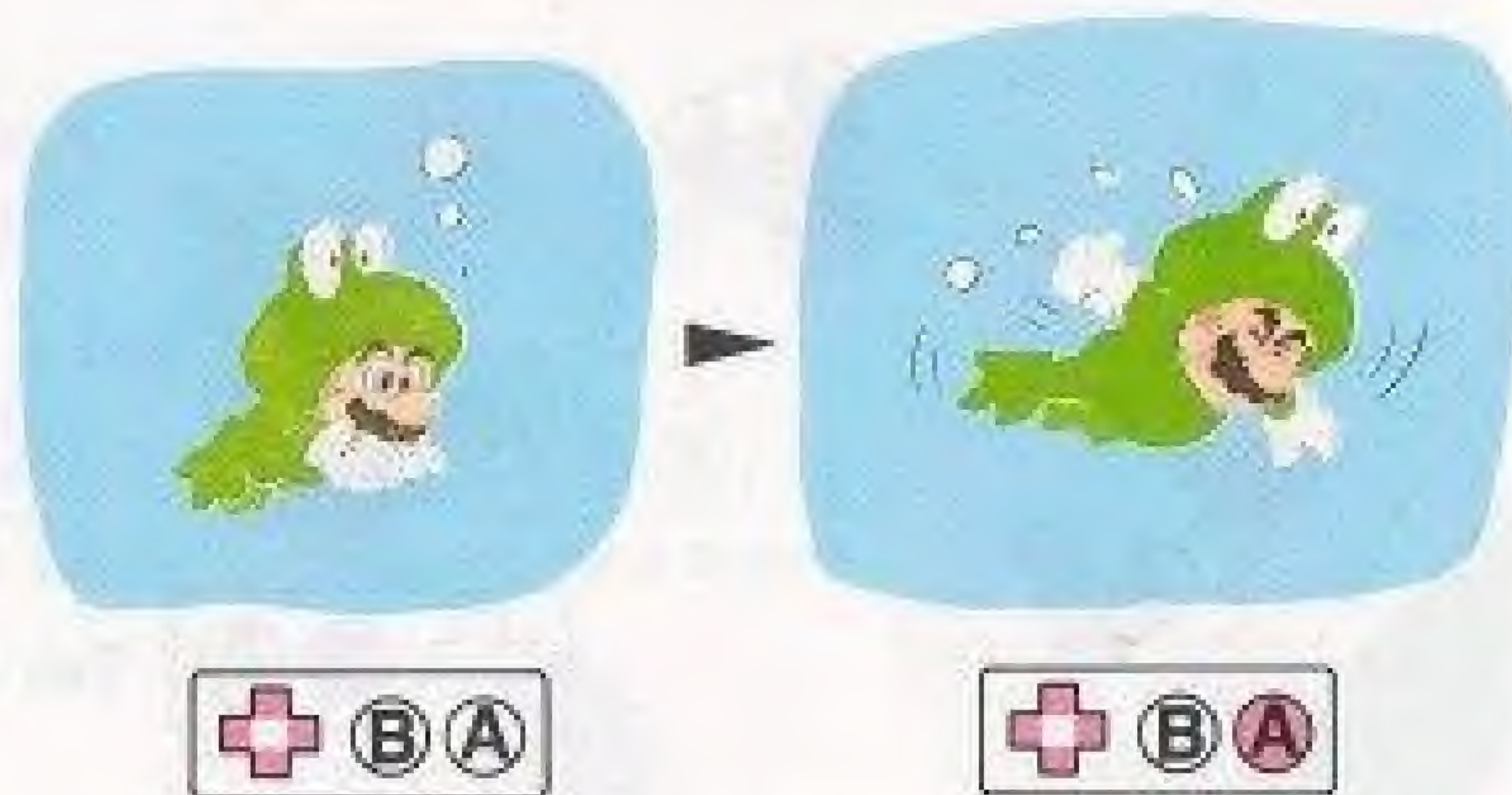

"This is the first time I've met up with Mario. I'm studying his moves very carefully."

MOVES YOU ALREADY KNOW



How the pipes work



Maneuvering in the water



Swimming



Jumping out of the water

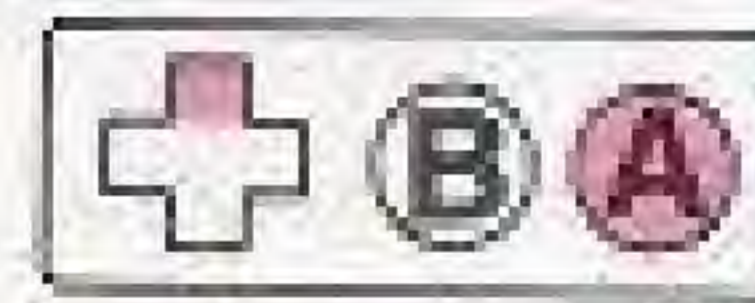

HOW TO PLAY SUPER MARIO BROS. 3

There are 8 kingdoms in the Mushroom World where Mario's adventures take place. Each kingdom has its own map. Mario can choose any road, but on the map there are a lot of points that you can't pass if you don't clear an action scene. At the start of the game, you get five players (the number of Marios remaining (4) will be shown.) In the game there are places where you can get power up items and even get extra Marios (1-UPs.) You must get the royal magic wands back from Bowser's 7 children.



The title screen will appear if you press the START Button while the game is in the demonstration mode. On the title screen, you can select a 1 player or 2 player game using the SELECT Button. If you press START again, the map of World 1 will appear and your game will begin.

"Ha ha! Mario and his friends must be getting very nervous now. I can hardly wait to meet up with him!"



HOW TO PLAY THE 1 PLAYER GAME

This is the World 1 map screen. Move Mario to the square with the "1" in it and press the A Button. This will make the action scene for World 1-1 appear.

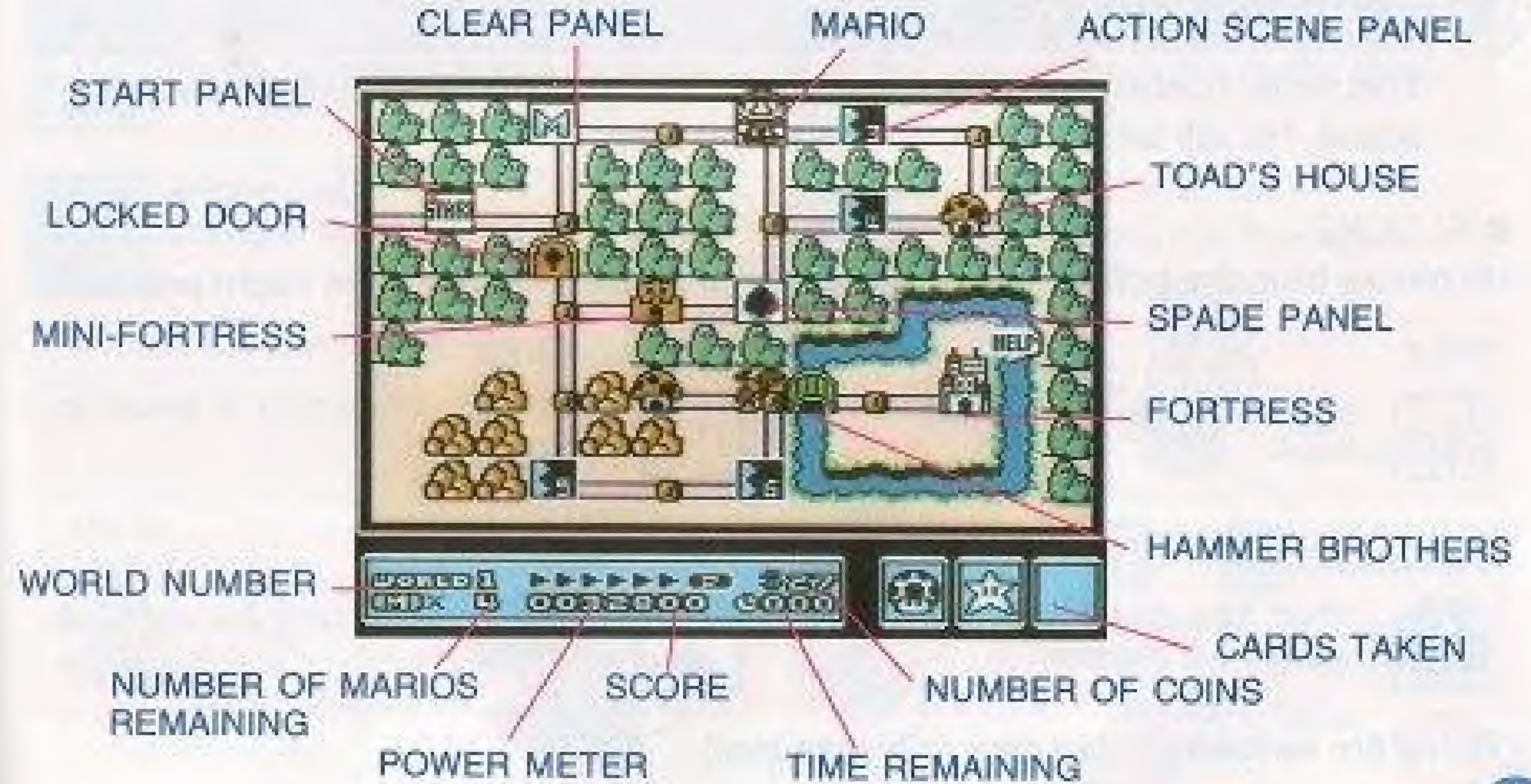



START PANEL

Mario starts from here.



ACTION SCENE PANEL

This panel contains an action scene. If Mario gets defeated while in an action scene, he will be put back on the World map.

● BLOCKS

Hit blocks from the bottom or ram them from the side. A useful item might pop out!

Brick



Super Mario can break this.

Question Block



Something interesting is bound to come out.

Switch Block



When you touch this, something strange will happen.

Jump Block



If your timing's right, you can jump very high.

(There are several other types of blocks too!)

● ITEMS



Coin

Gather 100 coins and you'll earn an extra Mario.



1-Up Mushroom

Gain an extra Mario.



Starman

Makes you invincible for a short time.



Super Mushroom

Changes Mario into Super Mario.



Super Leaf

Changes Mario into Raccoon Mario.



Fire Flower

Changes Mario into Fire Mario.

(There are many more surprises that aren't listed here!)

GAIN MORE POWER BY GATHERING ITEMS

Mario



Super Mushroom



Super Mario



Super Leaf



Fire Flower



Fire Flower



Fire Mario



Raccoon Mario



Super Leaf

● LIFTS

There are several types of lifts.



Rail Lifts

Travel along the rails.



Rotary Lifts

Sometimes these lifts spin. Be careful or you'll be spun off!



Donut Lift

More of a "drop" than a lift. When you step on these, they will shake and drop.



Directional Lift

You can control the direction of this lift by jumping and pressing the desired direction while in the air.



● GOAL

At the end of each action scene, you'll find a goal. In the goal, three kinds of cards (Mushroom, Flower, and Star) will flash. Jump up and touch the goal to grab a card and clear the level. If you get three cards, you will get an extra Mario. If you get three cards of the same type, you'll get even more extra Marios (see next page.)



3 Mushroom Cards

2 Extra Marios



3 Flower Cards

3 Extra Marios



3 Star Cards

5 Extra Marios

- * The Cards are displayed at the bottom of the screen.
- * At the end of an action scene, a bonus is added to your score depending on how much time you have left.
- * Any enemies remaining on the screen when you touch the goal will be turned into coins.

BEWARE! THE FOLLOWING ARE DEADLY!

You lose one Mario:

- * When you are touched by an enemy.
If you're Super Mario, you won't lose a life if you're touched by an enemy. You just go back to being ordinary Mario. If you're Fire Mario or Raccoon Mario, then you go back to being Super Mario. If you do get hit, Mario will flash for a few seconds. During this time, he is invincible.
- * When you fall into a hole or into fire.
- * When you run out of time (time remaining goes down to 0.)



CLEAR PANEL

When you clear on action scene, this panel appears. You may pass through this point freely.

(In the 2 player mode, if Luigi clears it, an "L" will be displayed.)



SPADE PANEL

Here, you play a slot machine type of game. The object is to line up the pictures. Every time you push the A Button, it will cause a line to slow down and stop. If you complete a picture, you can get extra Marios.



Mushroom Picture 2 Extra Marios

Flower Picture 3 Extra Marios

Star Picture 5 Extra Marios

(You can pass this point without playing if you wish.)



N-MARK SPADE PANEL

Occasionally this panel will appear on the map scene. It contains a "memory match" card game.

Choose a card using the + Control Pad then select it with the A Button. Then choose another card.

If they match, you will receive the item on the cards. You can continue to play until you miss twice.

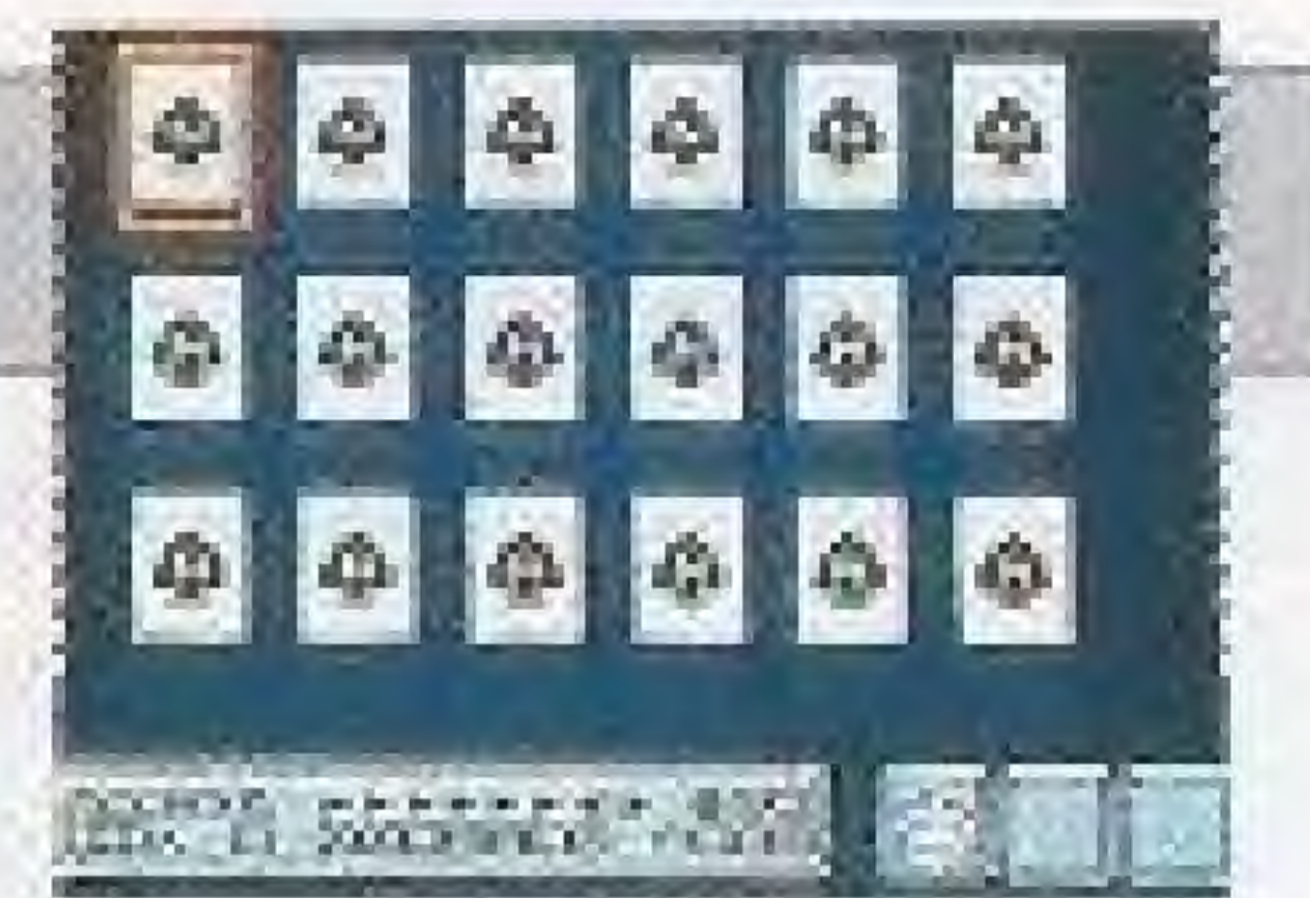

MINI-FORTRESS



LOCKED DOOR

The Mini-Fortresses are guarded by Boom Boom, a tough servant of Bowser. When you defeat him you get a magic ball and the Mini-Fortress tumbles to the ground. And the Locked Door gets unlocked.



TOAD'S HOUSE

Mario can get some useful items here. Stand in front of one of the treasure boxes and press the B Button. The treasure box will open and an item will pop out. (You can pass Toad's house without entering if you wish.)





HAMMER BROTHERS



The Hammer Brothers are bound to be hanging around somewhere on the map. When you meet up with them, a battle will take place. If you can defeat them, you will be rewarded with a special item.

(The Hammer Brothers differ from world to world.)



ITEMS YOU CAN USE ON THE MAP SCREEN

The items that you can get in Toad's house or by beating the Hammer Brothers can be used on the Map Screen. You can only use one item at a time. While on the Map Screen, press the B Button to display the items that you possess (they will be shown in the box at the bottom of the screen.) Choose the item you wish to use

by using left and right on the  Control Pad and activate it with the A Button. If you have more than one screen full of items, you can use up and down on the  Control Pad to flip to the different screens.

You can collect a maximum of 28 items. If you pick up a 29th item, it will take the place of the 28th item.

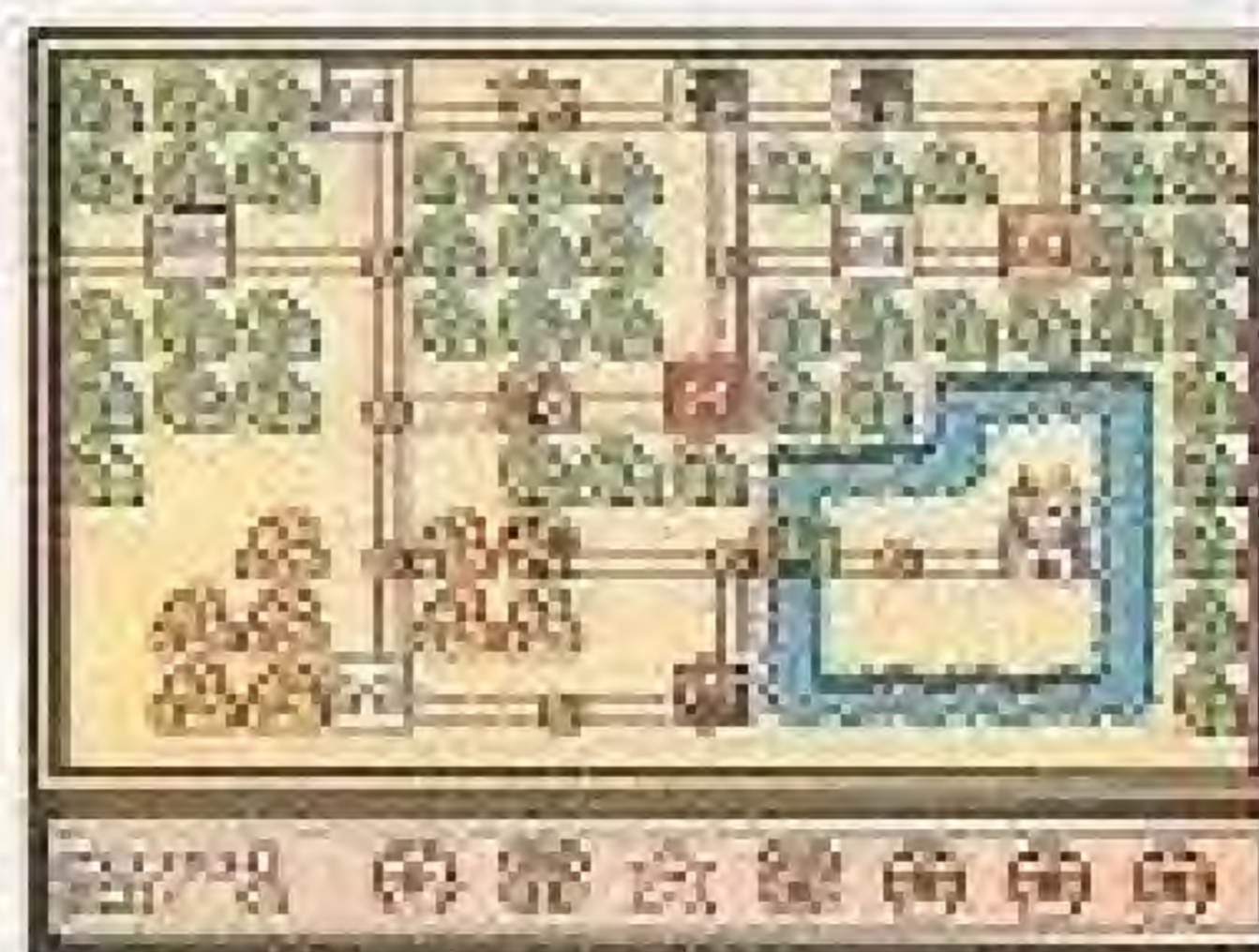

Super Mushroom
Changes Mario into Super Mario.



Fire Flower
Changes Mario into Fire Mario.



Super Leaf
Changes Mario into Raccoon Mario.



Frog Suit
Changes Mario into Frog Mario.



Tanooki Suit
Changes Mario into Tanooki Mario.



Jugem's Cloud
Allows you to pass an action scene without playing it.



Magic Wing
You can fly through an action scene until you run into an enemy.



Starman
When you start an action scene you will be invincible for a short time.



Hammer
Used to break rocks on the Map Screen.



Music Box
You can make Hammer Brothers and others fall asleep on the map.



Magic Whistle
Not much is known about the Magic Whistle. See if you can find it!



Anchor
This can stop the airships from moving.



"Wow! Mario sure has some neat new tricks...
I hope we can stop him!"



FORTRESS

This is the end fortress in World 1. The king has been transformed by one of Bowser's kids. You must retrieve the royal magic wand!



This is the guardian of World 1. You must jump on his head three times to defeat him. If you don't succeed in defeating him, the airship will move to a different place on the Map Screen. Chase it and challenge him again!

When you do defeat him, you get the magic wand and you are able to change the king back to his human form. Then it's on to World 2...



GAME OVER

When you lose all of your Marios, the game over screen appears. Choose either CONTINUE or END with the  Control Pad and press the START Button.

If You Choose CONTINUE

The game starts again from the beginning of the World that you were in.

- * You get to keep all of your items.
- * All clear panels go back to being action scene panels.
- * If you have destroyed the Mini-Fortress, it will stay destroyed.

If You Choose END

- * You will go back to World 1.



HOW TO PLAY THE 2 PLAYER GAME

In the 2 player game, player 1 (with controller 1) is Mario. Player 2 (with controller 2) is Luigi. Player 1 and player 2 take turns clearing the action scene panels. The two players can choose to cooperate or to compete against each other. If one player is in the same space on the map as the other player, then the 2 player battle mode (shown below) can be entered by pressing the A Button.

In the battle mode (just like the game Mario Bros.), when one player is punched from beneath by the other player, one of the punched player's cards will pop out. In this way, you can 'steal' your opponent's cards, or even get rid of cards that you don't want.

In the battle mode, the losing player is moved back to the point where the battle took place. The winner can continue into the game.

In the 2 player battle mode, you can't lose any of your extra players (even if you get hit by an enemy!)

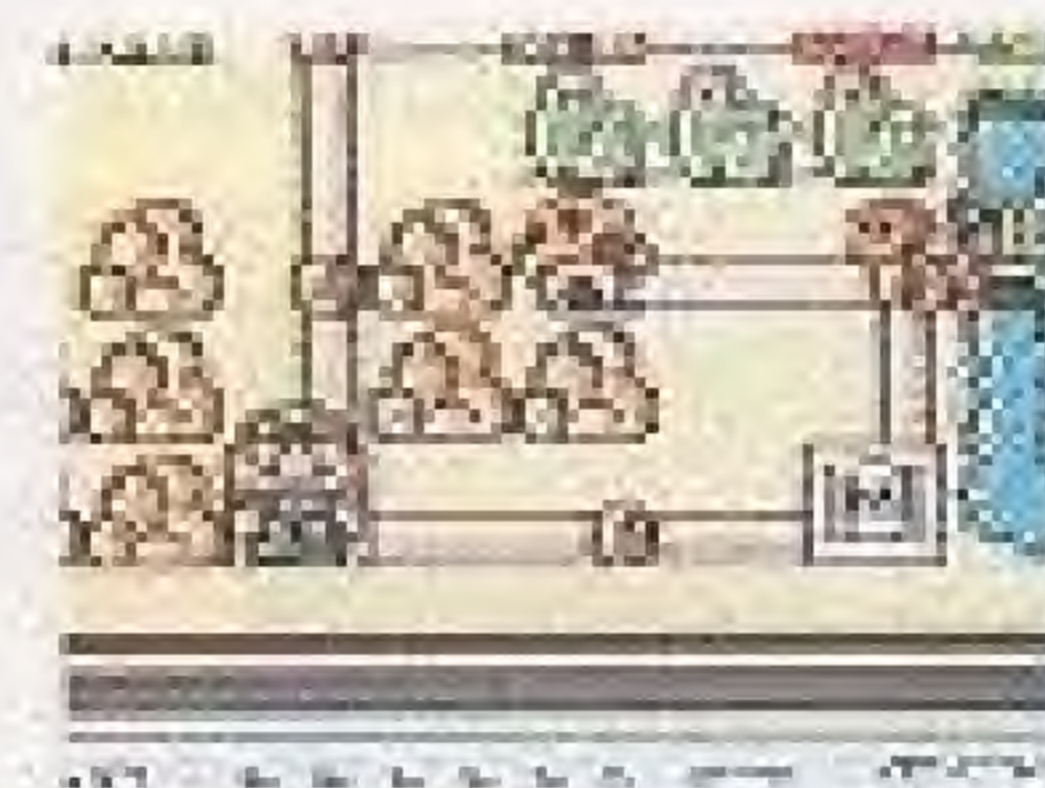

Luigi's going to start a battle with Mario.

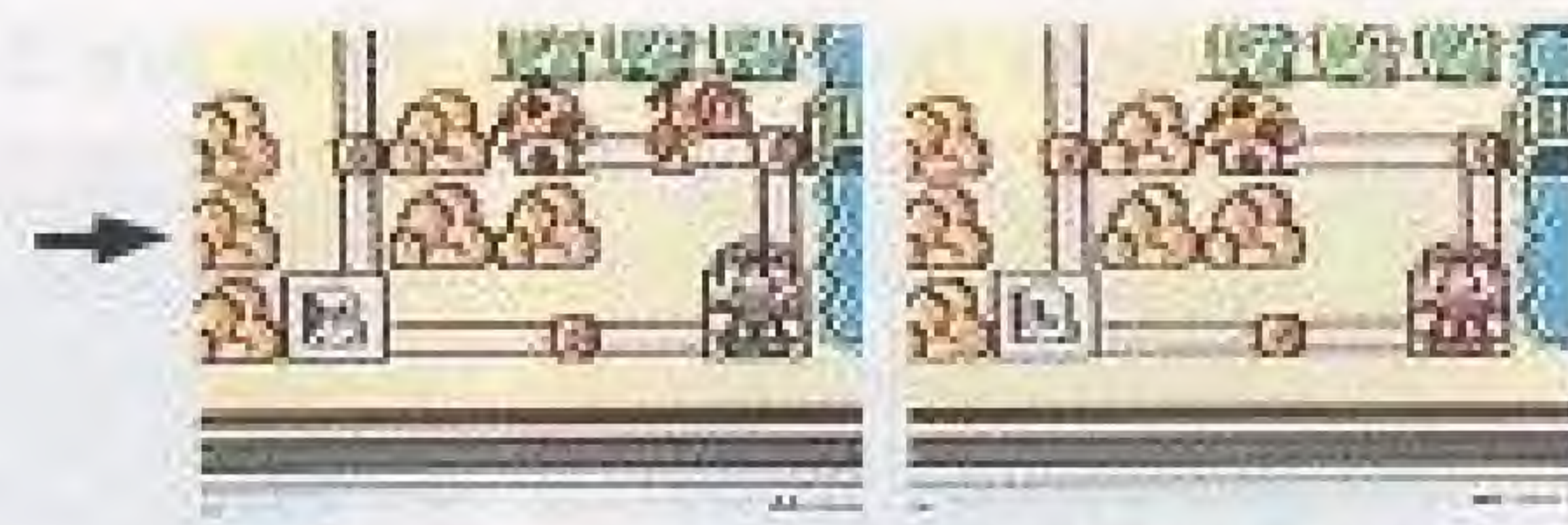

If Luigi wins...

If Mario wins...

HOW TO PLAY THE 'MARIO BROS.' GAME

One after another, Spiny, Crab, Fighter Fly and others jumps out of the pipes. The object of this game is to punch these enemies from below to overturn them, then kick them away. While the enemies are overturned, they can't move for a while. If you let an enemy stay overturned for long enough, they will get back up and be very angry! If you punch the POW you can overturn all enemies on the floor at once.

* The POW disappears after being punched three times.

When a total of 5 enemies have been beaten, the player wins. If you are touched by an enemy, you will lose.



Spiny



Crab



Fighter Fly



POW



In the 2 player battle mode, there are 3 other types of games (randomly picked.)



First one to get 5 coins wins.



Avoid the flames... get the coins!



5 coins are hidden in the blocks.

GAME OVER IN THE 2 PLAYER MODE

In the 2 player mode, when the game is over for one player, the game over screen will appear. Choose CONTINUE or END by using the  Control Pad, then the START Button.

If you choose CONTINUE

The game will start at the beginning of the world that you were in with all clear panels changed back to action scene panels.

If you choose END

The other player will continue their game alone.

T THE EIGHT KINGDOMS

Let's take a look at the 8 kingdoms that make up the Mushroom World. Each of them are truly unique... often so beautiful that you will forget that you are in a battle against the villainous Bowser. Stay alert! Anything can happen in the Mushroom World.

World 1 Grass Land

This is where Mario starts his journey. Many slopes and new enemies await your every move.

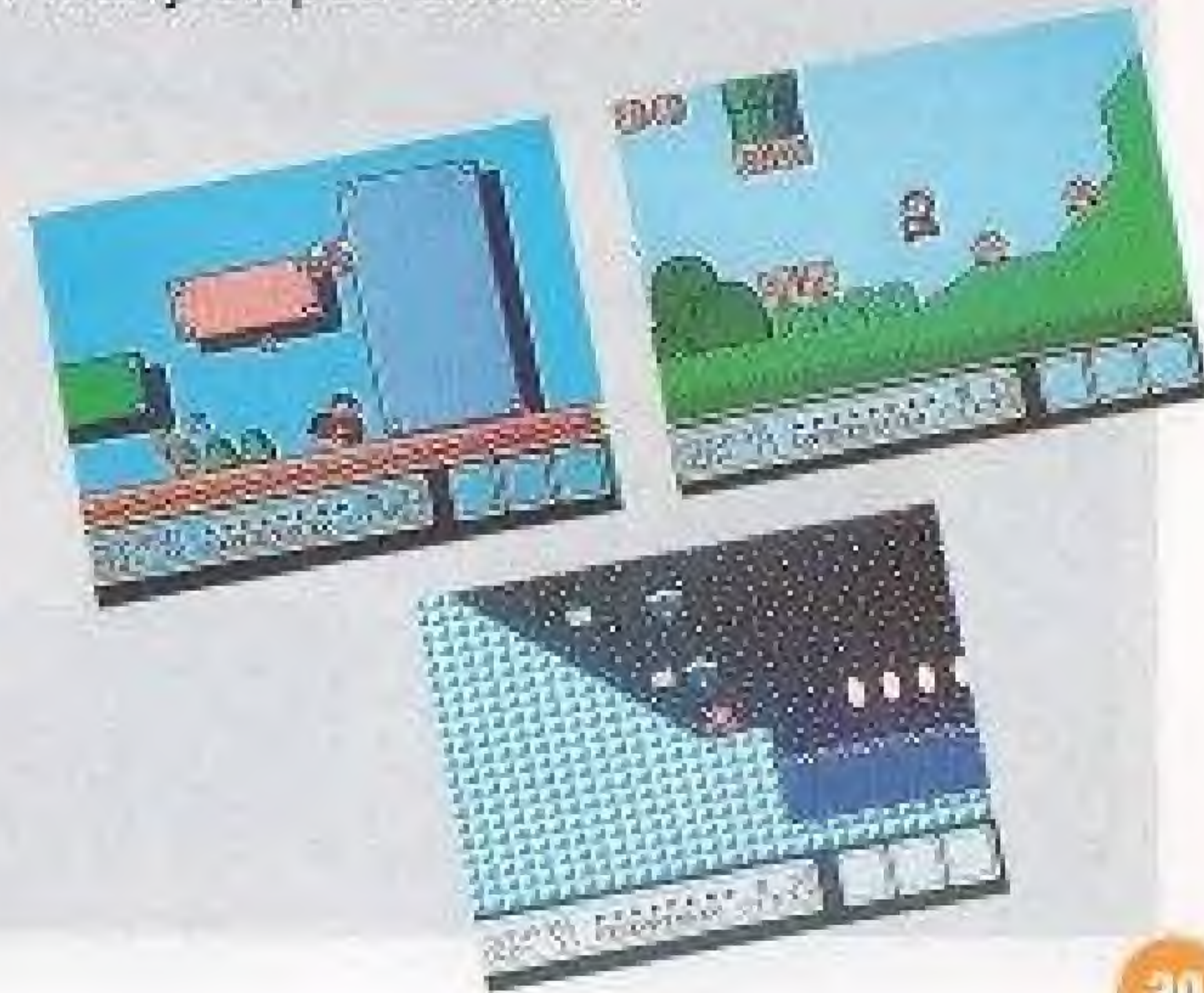

World 2 Desert Land

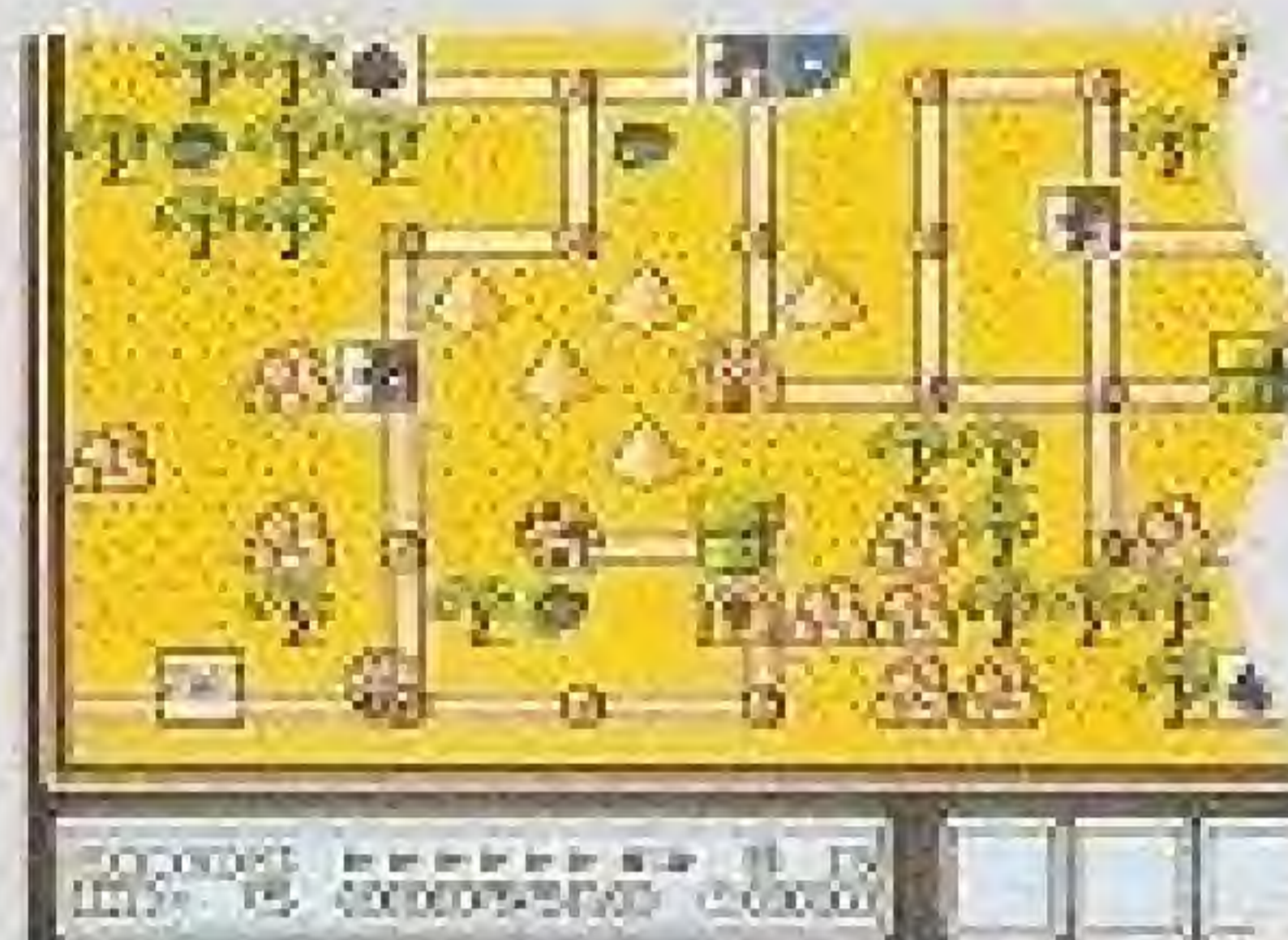

Be careful! The desert has conquered its share of weary travellers. Look out for the quicksand and be ready for the tricks ahead in the pyramid.



World 3 Water Land



This world is all wet! Only a great swimmer will be able to get through. Do your best to find a Frog Suit--it will help you immensely.



World 4 Giant Land



In this world, everything - the mountains, the rivers, the terrain, even the enemies - are huge. Even Super Mario is small compared to the Giants he will meet here.



World 5 Sky Land



Sky Land has many difficult sections. Raccoon Mario's flying ability is bound to help him here.



World 6 Ice Land

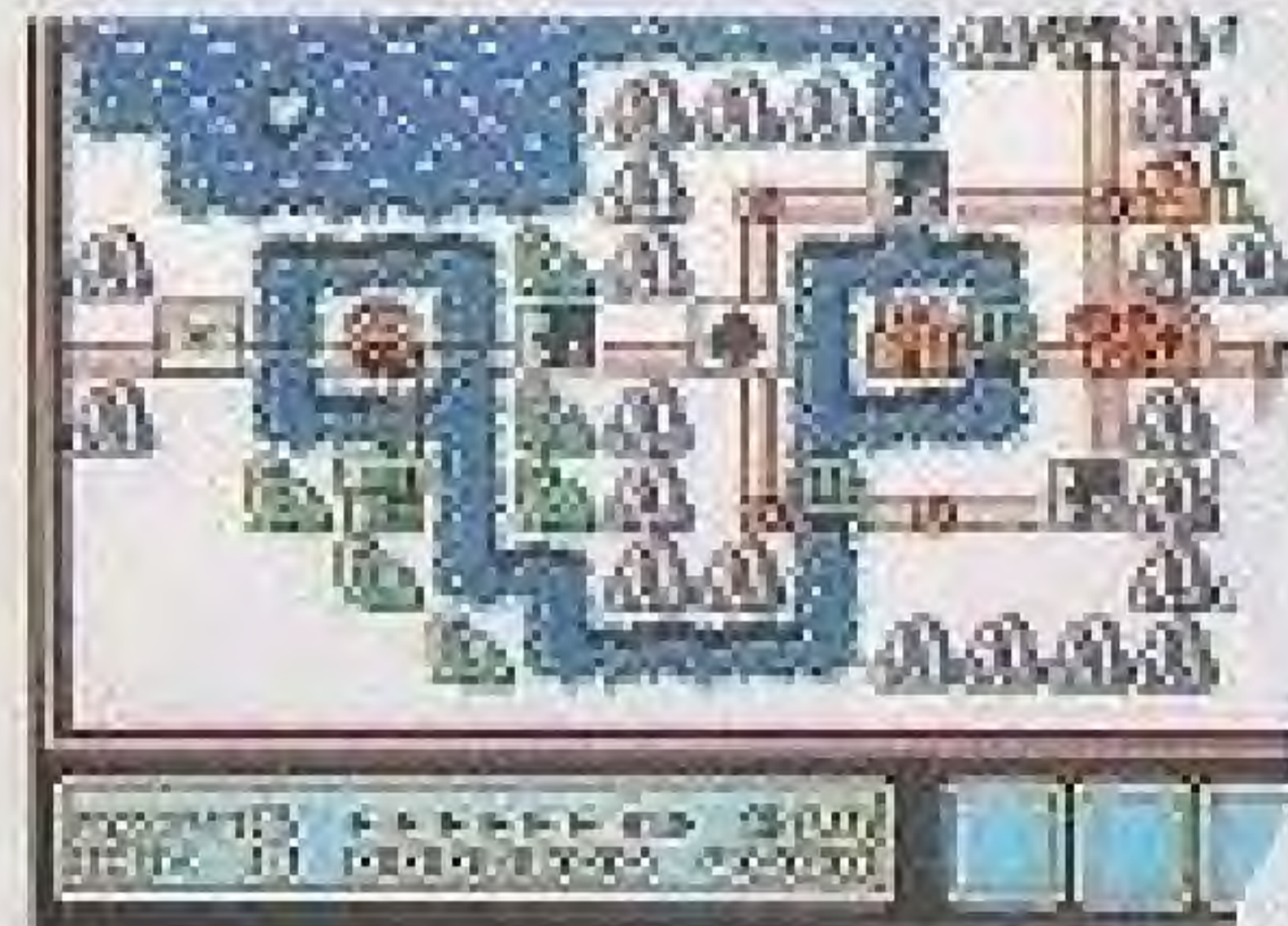

Everything is slippery in Ice Land. Be cautious as you proceed. This world is BIG, you may find some interesting items.



World 7 Pipe Land



Left and right, it seems that all you can see is a maze of pipes! With so many pipes around, there's bound to be lots of plant life to try to slow down Mario. Don't get discouraged, you're very close to your goal.



World 8 Dark Land

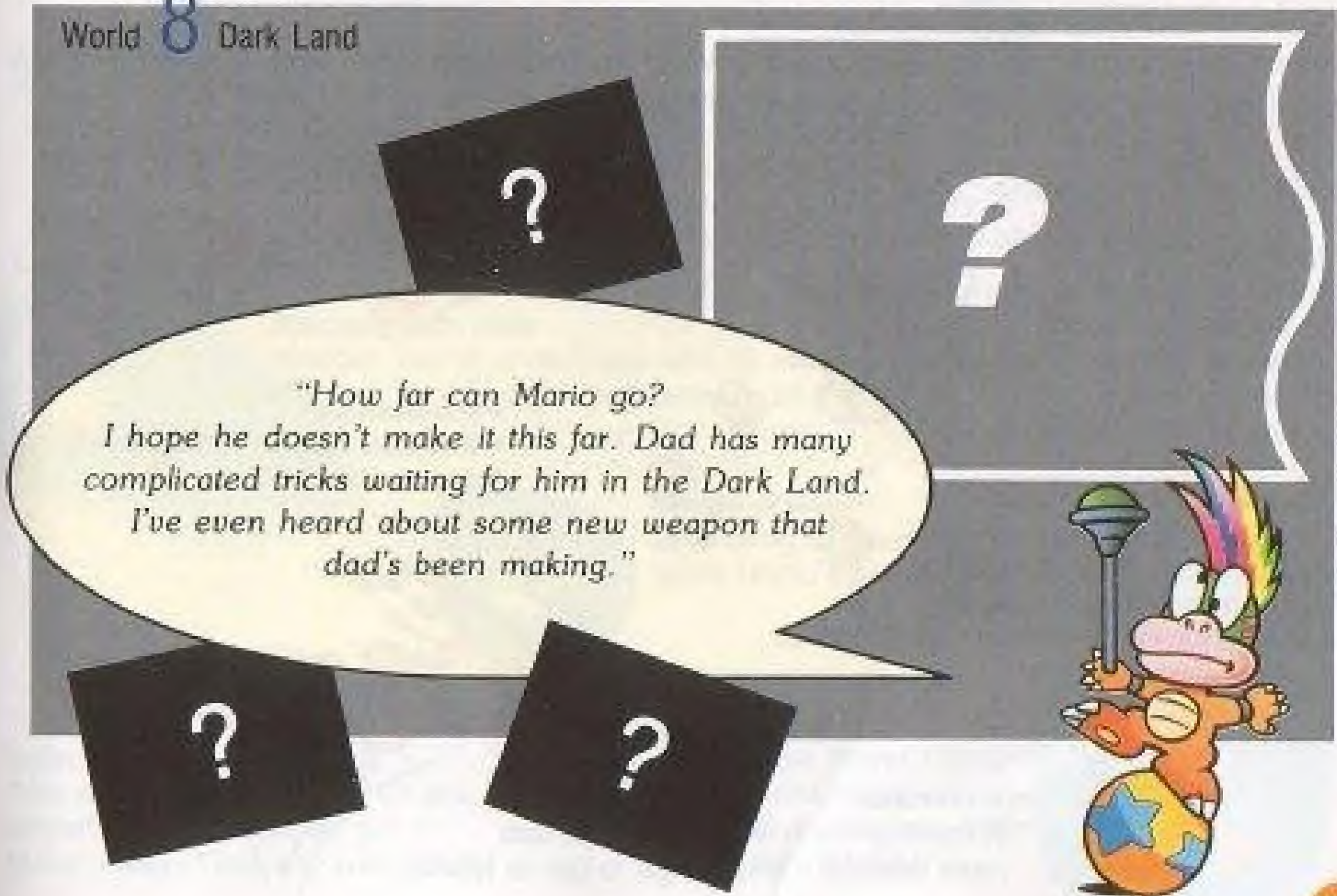

*"How far can Mario go?
I hope he doesn't make it this far. Dad has many
complicated tricks waiting for him in the Dark Land.
I've even heard about some new weapon that
dad's been making."*



THE CHARACTERS

A host of new characters have joined Bowser and his turtle tribe. With this information on these new enemies, you'll be well prepared.

Enemies above ground

Para-Goomba

A new flying version of an old familiar enemy. Once you jump on it, it loses its wings.



Micro-Goombas

These are Para-Goomba's children that will cling to Mario. Pressing the A Button rapidly is the only way to get them off of Mario.

Firesnake

A moving chain of fireballs that can pass through many things to get to Mario.



Para-Beetles

Mario can ride on top of these flying beetles.



Fire Chomp

A black ball followed by a chain of fire that shoots fireballs at Mario. Look out! They can explode!

Enemies in the Water



Bloober with kids

Bloober swims underwater with its children. It has a relative, the Scattering Bloober, whose children scatter in all directions.



Cheep-cheep

Swimming in the sea, this thorny fish will try to block Mario's path.

Jelectro

This electric jellyfish may sit still anywhere in the sea to get in Mario's way. They are invincible!



Lava Lotus

An artificial flower that grows and blooms deep in the sea. Look out for the lava balls that it will release.



Chain Chomp

Although tied to a block by a chain, Chain Chomp is quite a tough enemy. Only invincible Mario is able to defeat him.

Enemies underground

Buzzy Beetle

He's back again. This time he can walk on the ceiling.



Spike

Spike is usually easy going. But once he sees Mario he starts throwing spiked balls at him. Spike occasionally appears above ground too.



Bob-omb

As long as he's walking, Bob-omb seems cute. Be very careful when he starts to flash. He will explode destroying everything around him.



Enemy in an Airship

Rocky Wrench

Rocky is a turtle who kind of looks like a mole. He will suddenly appear and start to throw wrenches at Mario.



Enemies in the Fortress

Thwomp

If Mario comes close, Thwomp will try to crush him. Since Thwomp is covered with thorns, Mario can't touch him.



Rotodisc

Spins around making maneuvers difficult for Mario.



"Boo" Diddly

Boo is too shy to look anyone in the face. But when you turn around...



Hot Foot

Usually, Hot Foot stays on a burning candle. If Mario gets close, Hot Foot will start to chase him.



Dry Bones

A mummified turtle? No matter how many times you jump on it, it'll come back to life.



Stretch

A ghost that hides under the floor waiting for anyone to come along.



The Boss of the Mini-Fortresses

Boom Boom

This is the boss that controls the Mini-Fortresses. Boom Boom hurls himself at Mario with his arms swinging. Mario needs to jump on Boom Boom 3 times to defeat him. Be careful though, Boom Boom gets quicker every time he gets jumped on.



The Pirana Plants

Venus Fire Trap

This pirana plant emits fireballs. They come in different sizes and are very dangerous.



Ptooie

These flowers blow out spiked balls from their mouths. There are walking ones as well as ones that live in pipes.



Walking Piranas

These small flowers jump up when Mario gets close. Some of them can move around.



Munchers

Munchers wait quietly for Mario. They are invincible, no attacks can hurt them.

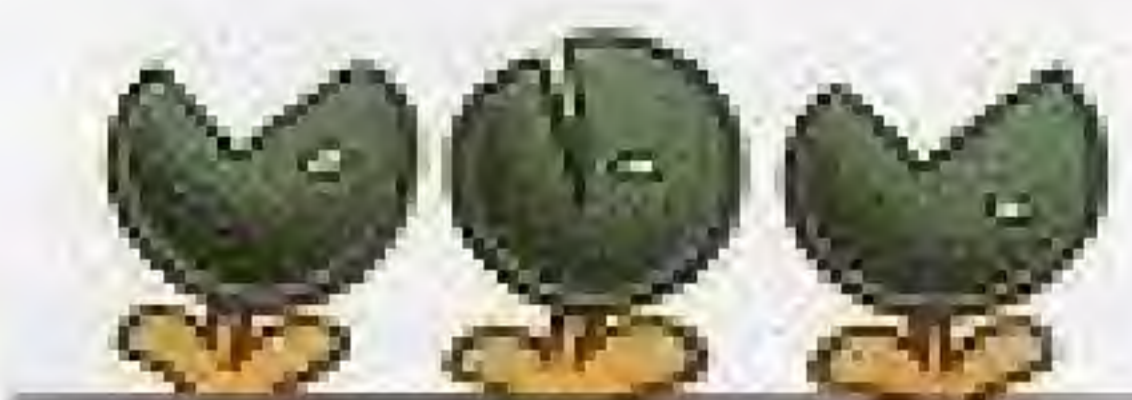

Hammer Brothers

Boomerang Brothers

They have boomerangs instead of hammers. They can throw two boomerangs at once.

Fire Brothers

These guys shoot balls of fire at Mario.

Sledge Brothers

The Sledge Brothers shake the earth when they jump. They also throw hammers. Try to jump up when the Sledge Brothers hit the ground. If you don't, Mario will lose his footing.



*"Quite an exciting game isn't it?
I'm glad to know that we have such
powerful enemies helping us out.
We have more guys helping us besides
these... but don't tell Mario."*

To Mario's Players:

Thanks for selecting Super Mario Bros. 3. We've been working hard to make this game even better than Super Mario Bros. 1 and 2. In addition to the action scenes, we've added a World Map on which you can plot your progress as well as play a new 2 player game. In Super Mario Bros. 3, you will find many more hidden things than in the first two games in the series. We think that you will find it much more challenging as well. Have fun!

Yours truly,
Mario's Staff

COMPLIANCE WITH FCC REGULATIONS

This equipment generates and uses radio frequency energy and if not installed and used properly, that is, in strict accordance with the manufacturer's instructions, may cause interference to radio and television reception. It has been type tested and found to comply with the limits for a Class B computing device in accordance with the specifications in Subpart J of Part 15 of FCC Rules, which are designed to provide reasonable protection against such interference in a residential installation. However, there is no guarantee that interference will not occur in a particular installation. If this equipment does cause interference to radio or television reception, which can be determined by turning the equipment off and on, the user is encouraged to try to correct the interference by one or more of the following measures:

- Reorient the receiving antenna
- Relocate the NES with respect to the receiver
- Move the NES away from the receiver
- Plug the NES into a different outlet so that control Deck and receiver are on different circuits.

If necessary, the user should consult the dealer or an experienced radio/television technician for additional suggestions. The user may find the following booklet prepared by the Federal Communications Commission helpful:

How to Identify and Resolve Radio—TV Interference Problems.

This booklet is available from the U.S. Government Printing Office, Washington, D.C. 20402, Stock No. 004-000-00345-4.

90-DAY LIMITED WARRANTY NINTENDO GAME PAKS

90-DAY LIMITED WARRANTY:

Nintendo of America Inc. ("Nintendo") warrants to the original consumer purchaser that this Nintendo Game Pak ("PAK") shall be free from defects in material and workmanship for a period of 90 days from date of purchase if a defect covered by this warranty occurs during this 90-day warranty period, Nintendo will repair or replace the PAK, at its option, free of charge.

To receive this warranty service:

1. DO NOT return your defective Game Pak to the retailer.
2. Notify the Nintendo Consumer Service Department of the problem requiring warranty service by calling: 1-800-255-3700. Our Consumer Service Department is in operation from 4:00 A.M. to 10:00 P.M. Pacific Time, Monday through Saturday (times subject to change.) Please Do Not send your Pak to Nintendo before calling the Consumer Service Department.
3. If the Nintendo Service Representative is unable to solve the problem by phone, he will provide you with a Return Authorization number. Simply record this number on the outside packaging of your defective PAK, and return your PAK FREIGHT PREPAID AND INSURED FOR LOSS OR DAMAGE, together with your sales slip or similar proof-of-purchase within the 90-day warranty period to:

Nintendo of America Inc.
NES Consumer Service Department
4820 — 150th Avenue N.E.
Redmond, WA 98052

This warranty shall not apply if the PAK has been damaged by negligence, accident, unreasonable use, modification, tampering, or by other causes unrelated to defective materials or workmanship.

REPAIR/SERVICE AFTER EXPIRATION OF WARRANTY:

If the PAK develops a problem requiring service after the 90-day warranty period, you may contact the Nintendo Consumer Service Department at the phone number noted above. If the Nintendo Service Representative is unable to solve the problem by phone, he may advise you of the approximate cost for Nintendo to repair or replace the PAK and may provide you with a Return Authorization number.

You may then record this number on the outside packaging of the defective PAK and return the defective merchandise, FREIGHT PREPAID AND INSURED FOR LOSS OR DAMAGE, to Nintendo, and enclose a money order payable to Nintendo of America Inc. for the cost quoted you. (Repairs may also be charged on a VISA or MASTERCARD credit card.)

If after personal inspection, the Nintendo Service Representative determines the PAK cannot be repaired, it will be returned and your payment refunded.

WARRANTY LIMITATIONS:

ANY APPLICABLE IMPLIED WARRANTIES, INCLUDING WARRANTIES OF MERCHANTABILITY AND FITNESS FOR A PARTICULAR PURPOSE, ARE HEREBY LIMITED TO NINETY DAYS FROM THE DATE OF PURCHASE AND ARE SUBJECT TO THE CONDITIONS SET FORTH HEREIN. IN NO EVENT SHALL NINTENDO BE LIABLE FOR CONSEQUENTIAL OR INCIDENTAL DAMAGES RESULTING FROM THE BREACH OF ANY EXPRESS OR IMPLIED WARRANTIES.

The provisions of this warranty are valid in the United States only. Some states do not allow limitations on how long an implied warranty lasts or exclusion of consequential or incidental damages, so the above limitations and exclusion may not apply to you. This warranty gives you specific legal rights, and you may also have other rights which vary from state to state.

MEMO

MEMO